

FORM 20854

(1157)

Printed in U.S.A.

SINGER^{*}

246-15

From the library of: Diamond Needle Corp

THE SINGER COMPANY

* A Trademark of THE SINGER COMPANY

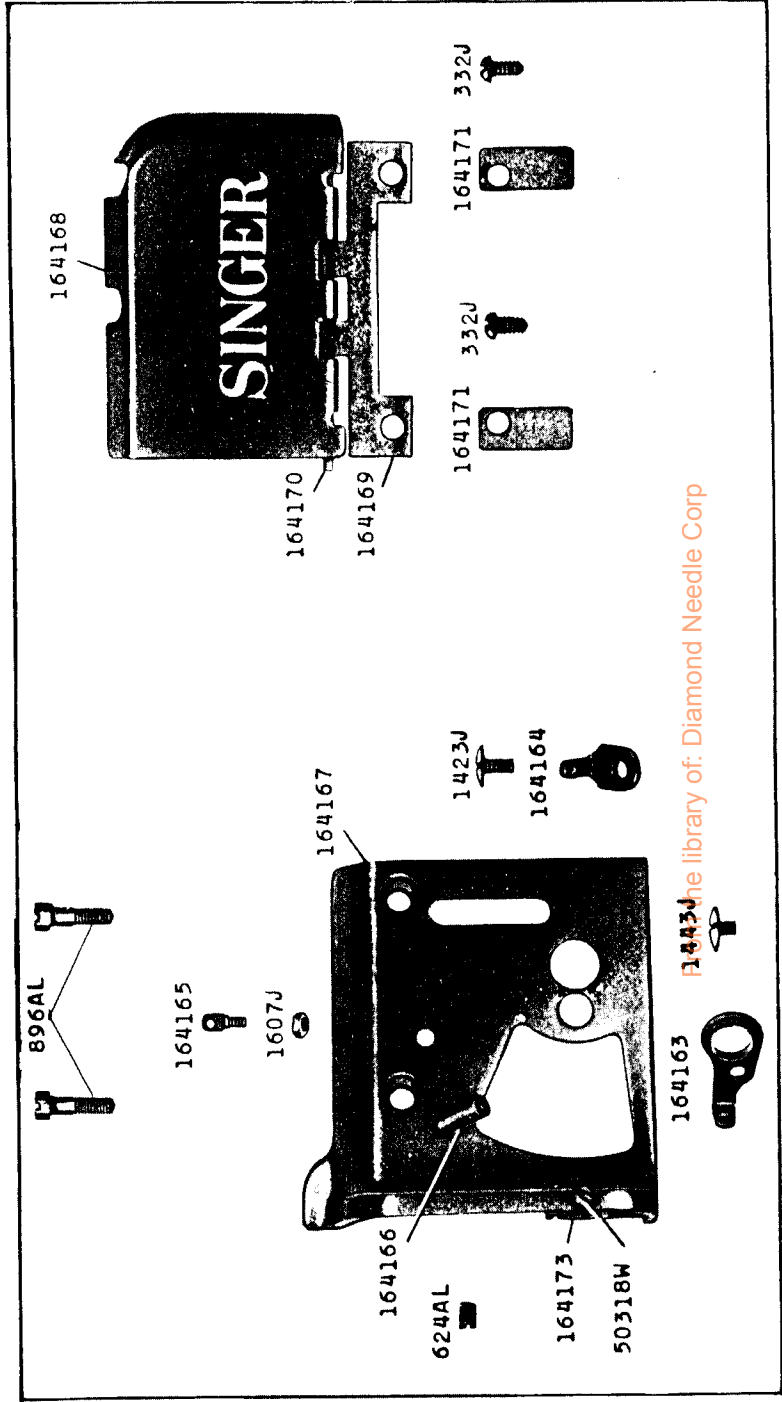

Placed in the library of: Diamond Needle Corp

24764 - 1/6

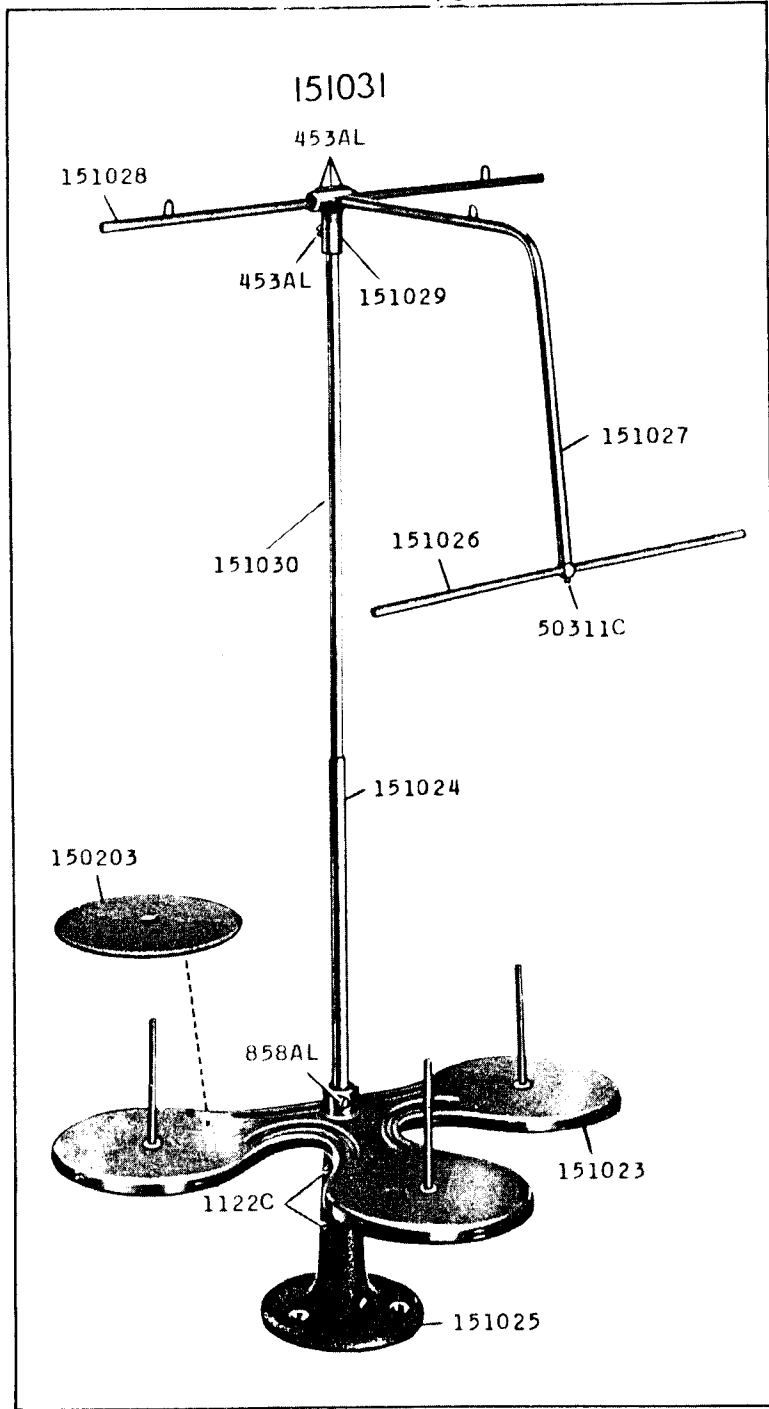

24772 - 1/3

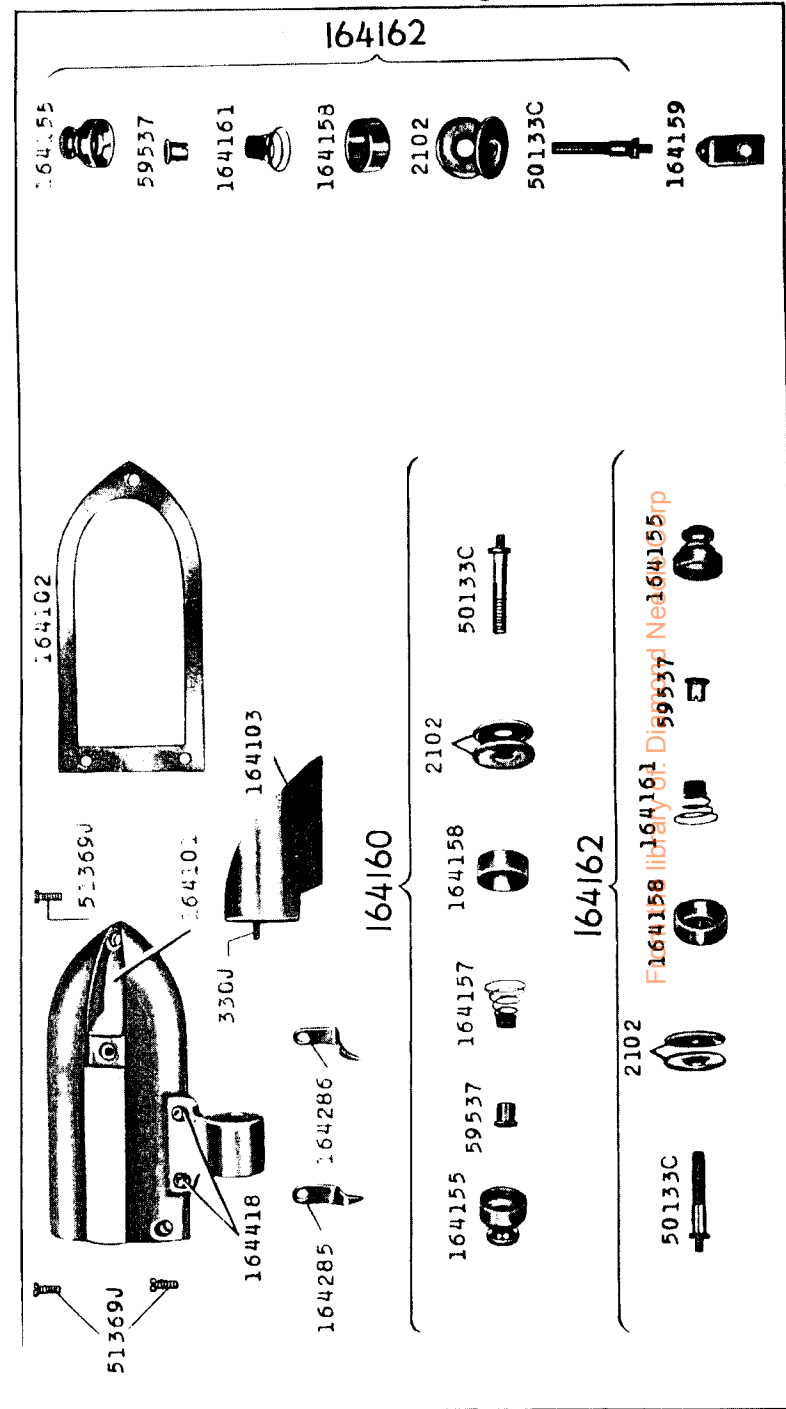

164162

- 164155
- 59537
- 164161
- 164158
- 2102
- 50133C
- 164159

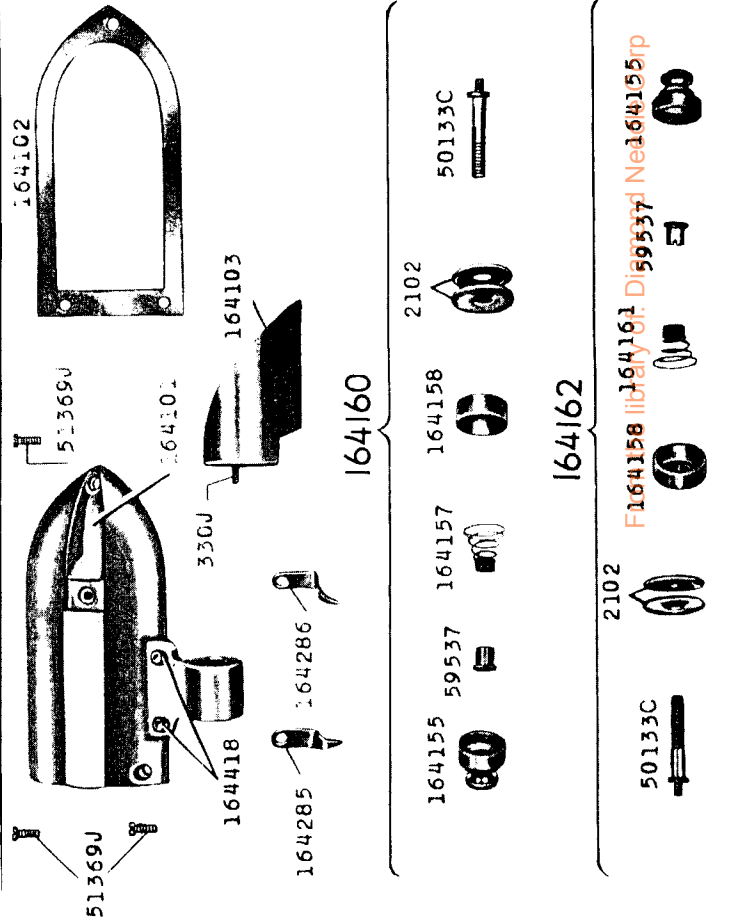

164102

51369U

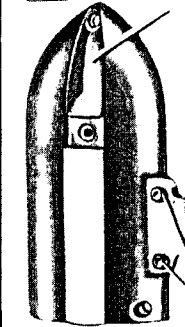

51369U

164101

330J

164418

164285

164286

164103

164160

2102

164158

164157

59537

164155

50133C

164159

164158

164161

164155rp

164162

2102

50133C

164158

164161

59537

164155rp

164159

24813-1/3

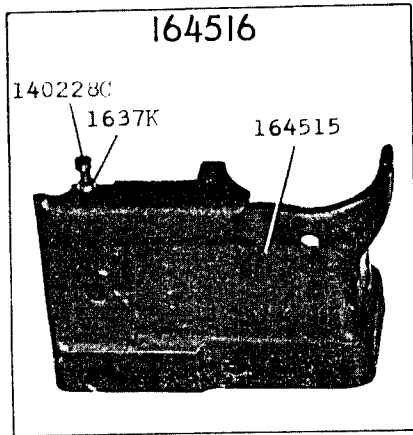
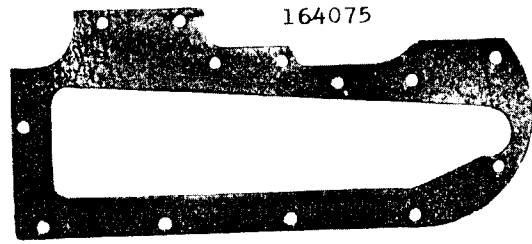
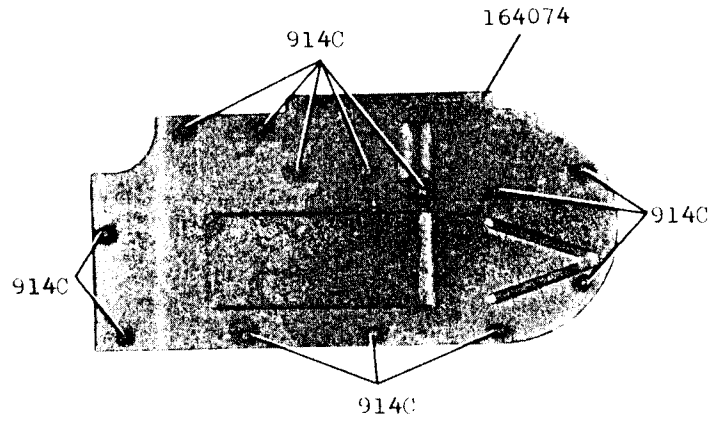

140228C
1637K

164515

914J



50571J



24829-1/2

16413C

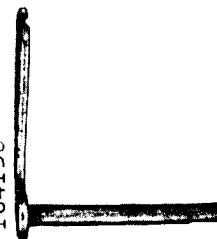

164139

164137

462AL

624AL

51846

164142



50060K

164085



51023W

164143 164144 164194



164143



164143



164143

164143

164118

164117

140596AL

164112

164115

1083C

164114

452AL

164113

164110

164111

164373

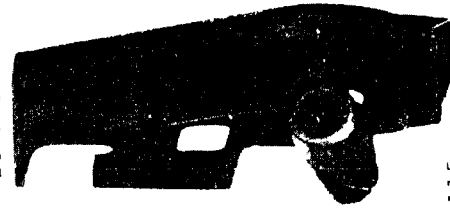

1259AL

50073J



50073J



From the library of 517206/rd Needle Corp

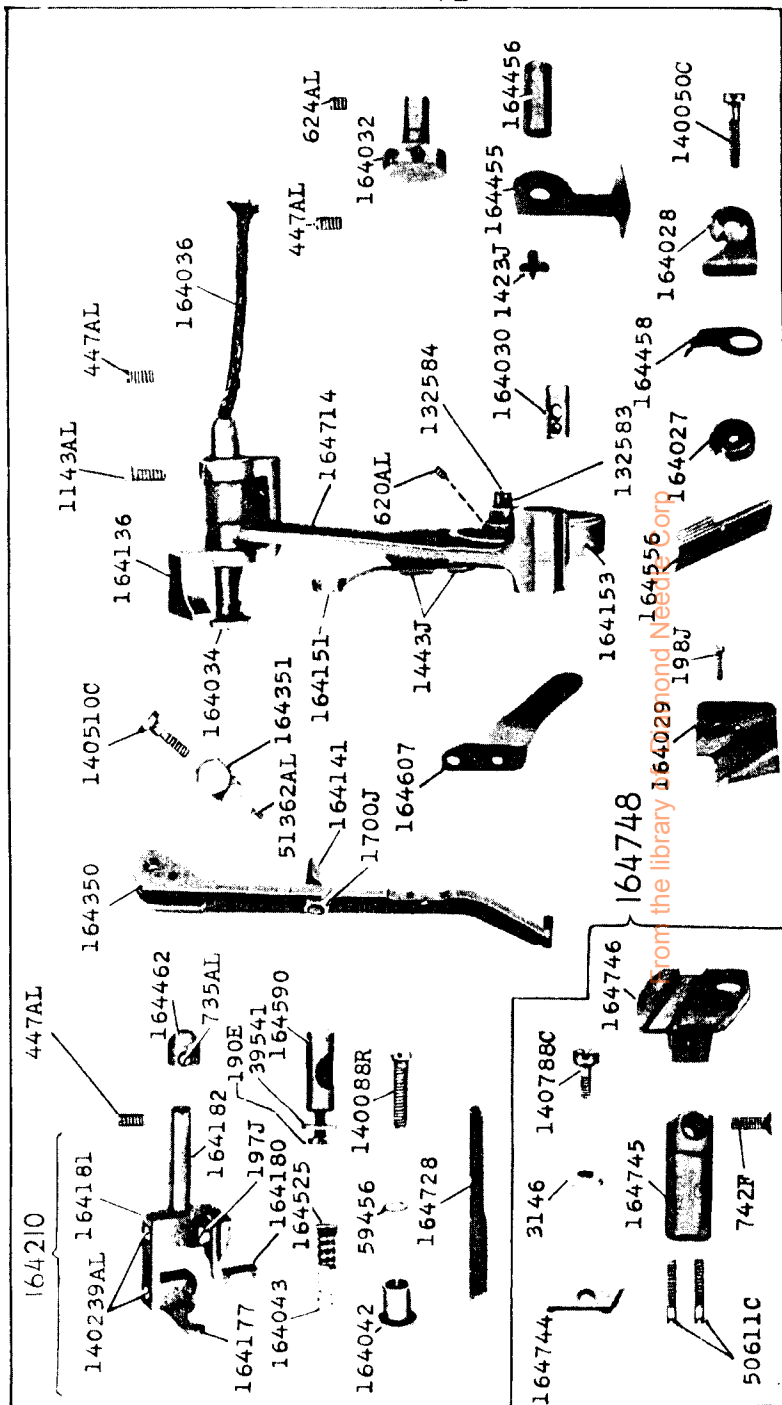
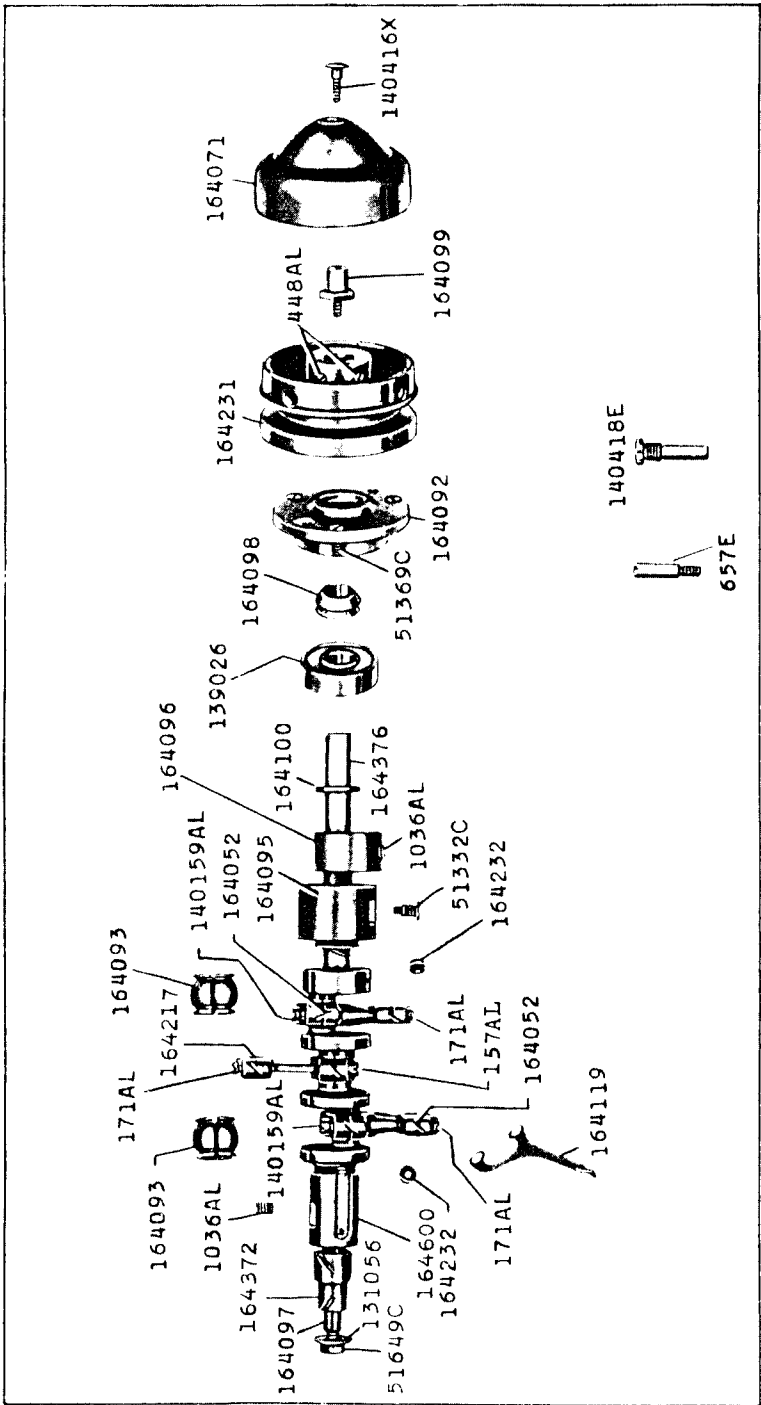

24861-2/3

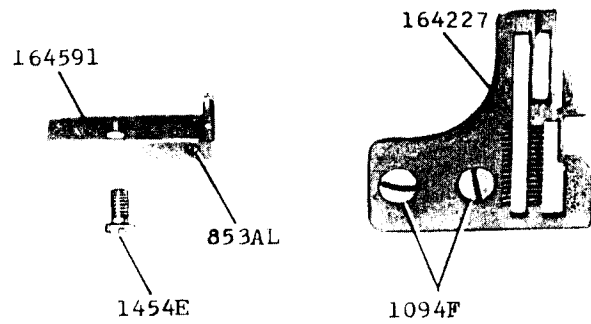
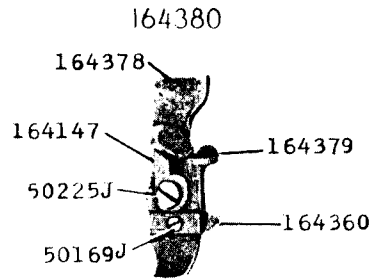
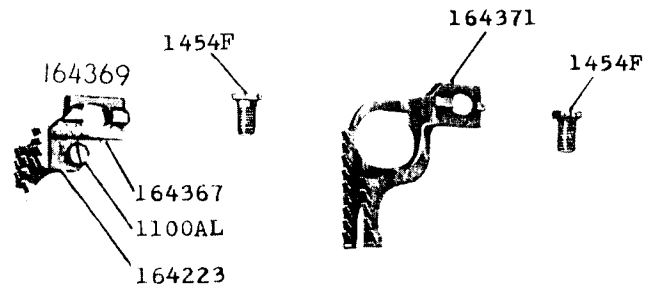

24862-2/3

164391

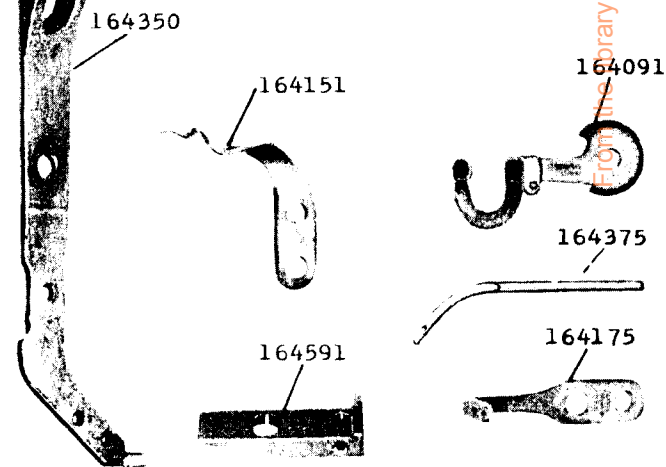
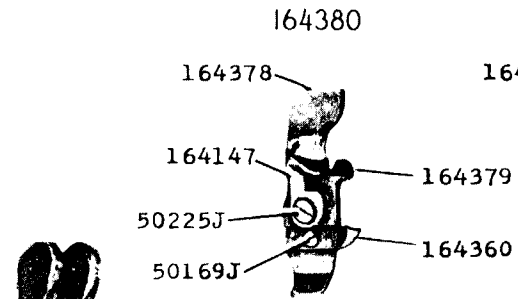
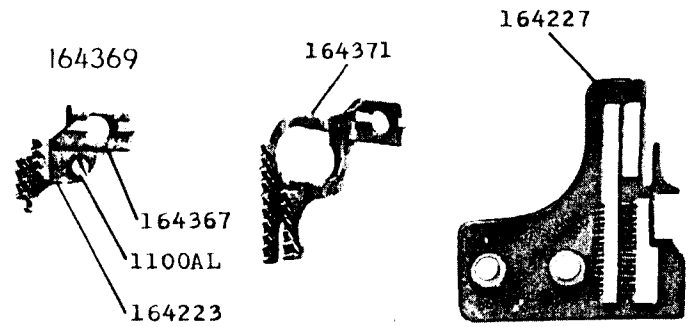

From the Library of: Dikson Needle Corp

24863-1/2

164445

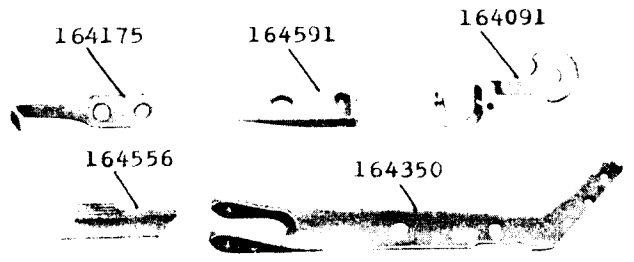
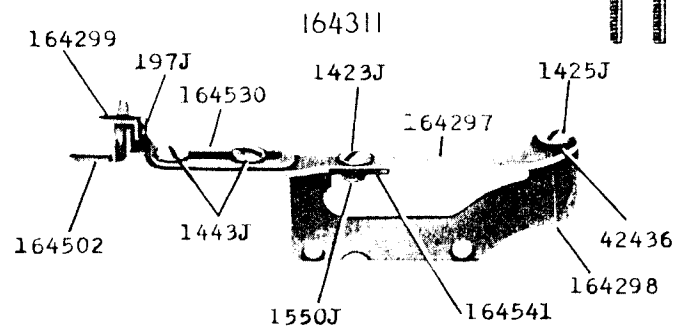
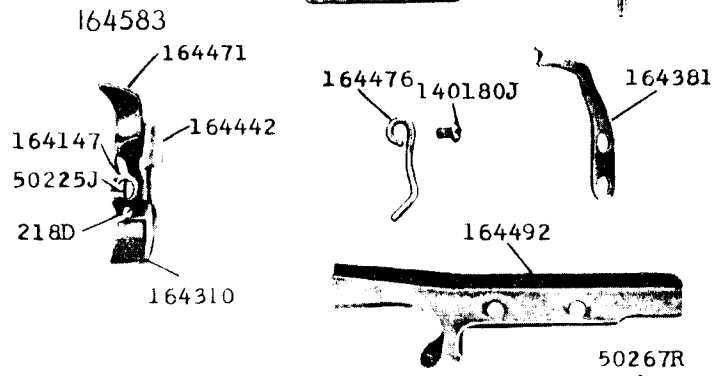
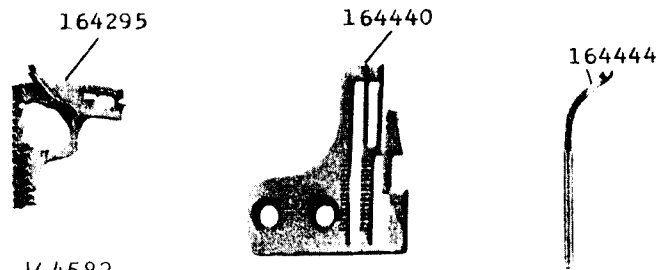

24864-1/2

164542

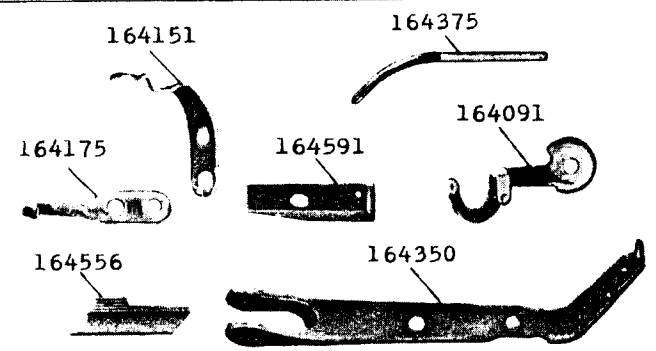
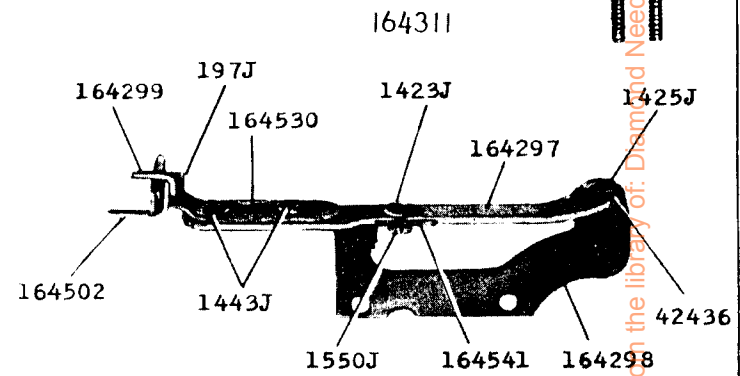
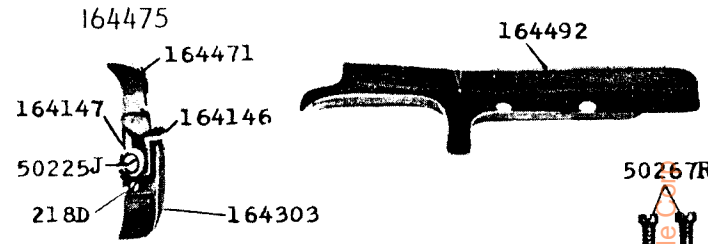
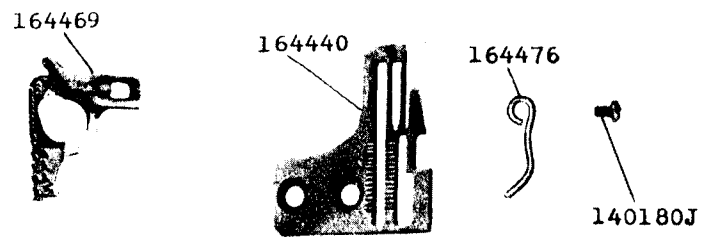

From the library of: Disarmed Needle Co.

24865-1/2

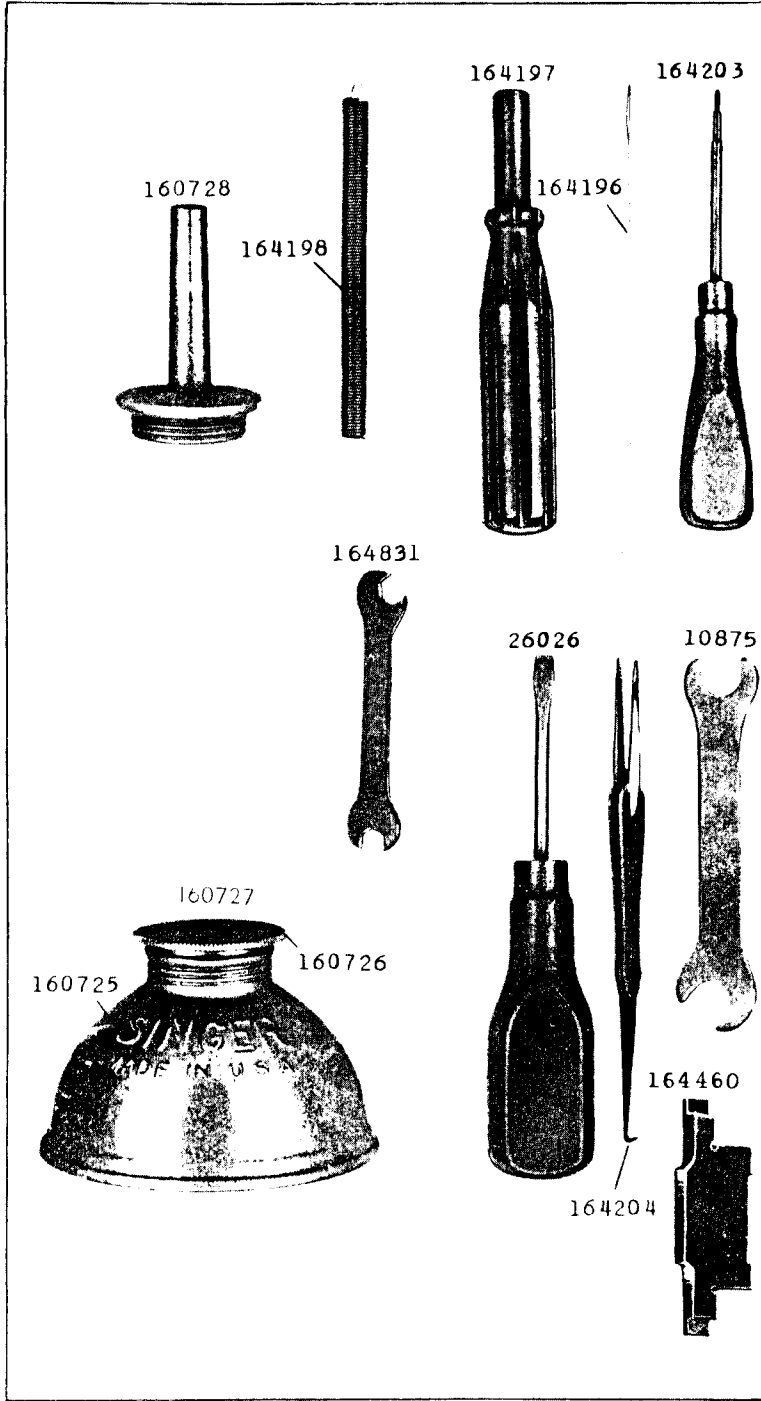

24866 - 1/4

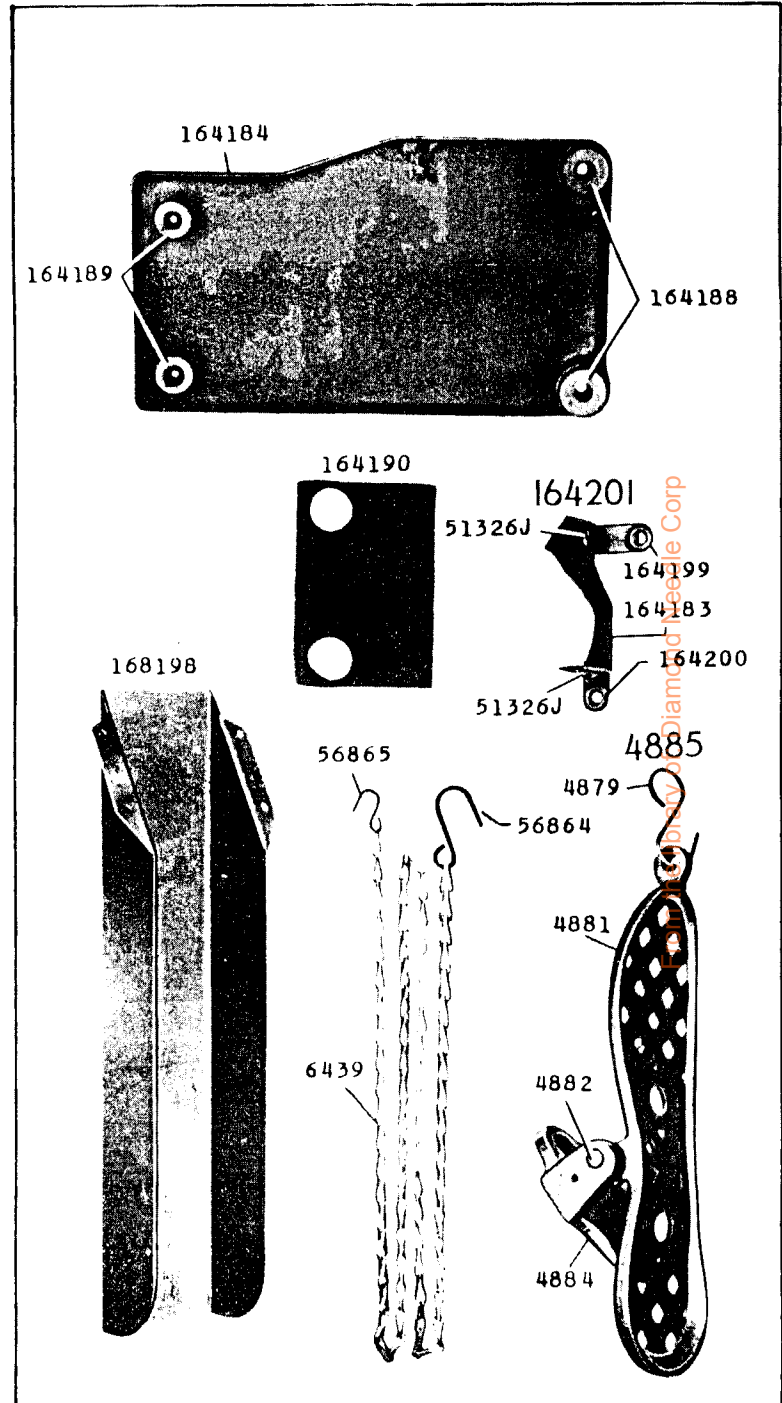

24867 - 1/6

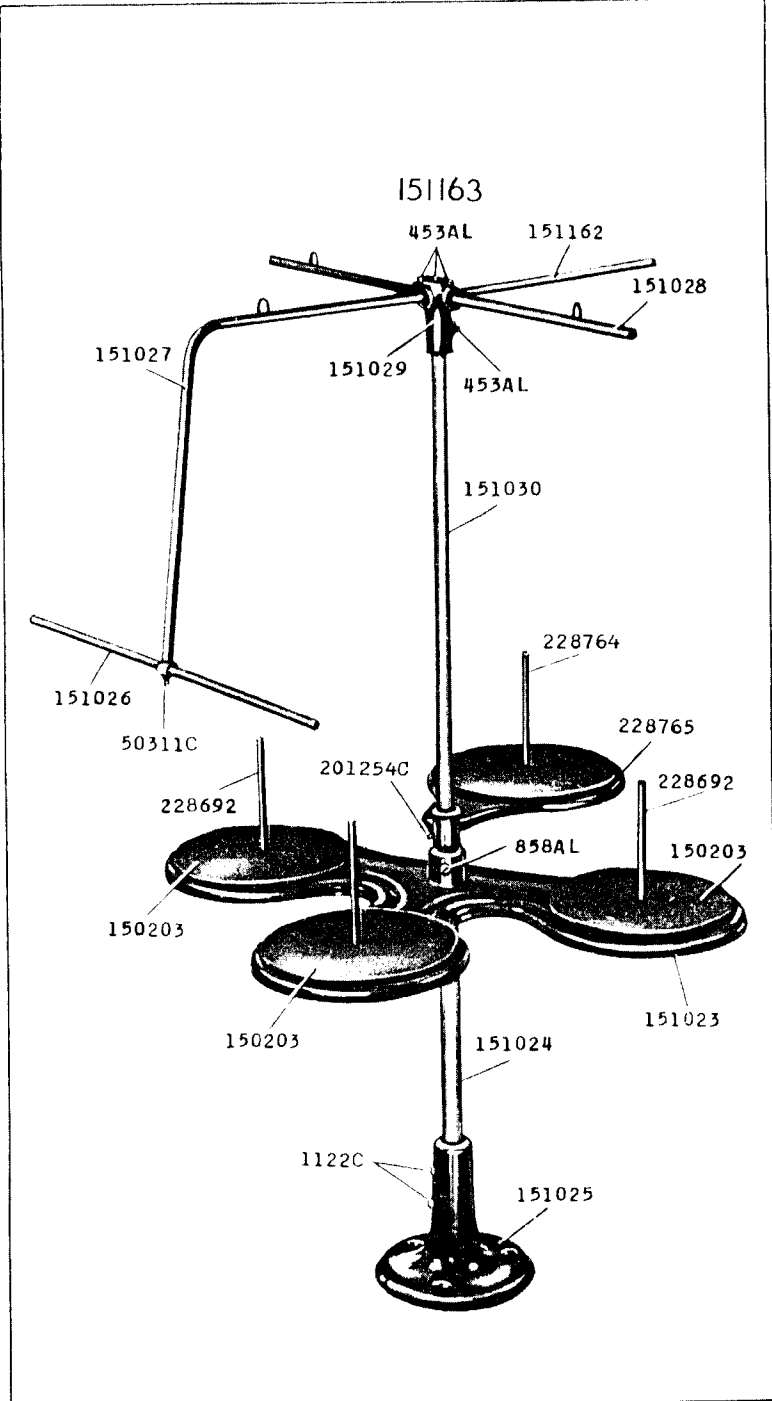

From the library of: Diamond Needle Corp